

THANK YOU TO DONORS AND SPONSORS FOR THE LIGHT HORSE SHOW

Event Donors:

SWAN WOOD SHAVINGS INC.

Novelty Costume Class

LLOYD'S JEWELLERS, Swan River

Horse & Rider Parade Glamour

Peavey Mart, Swan River

PeeWee Local Showmanship, Walk & Trot

COOK & COOKE INSURANCE/FINANCIAL, Swan River

Local Saddle Horse

SWAN RIVER ELKS CLUB, Swan River

Champion Pony on Halter

PNB STOCK FARM, Swan River

Grand Champion Mare or Filly

COOK & COOKE INSURANCE/FINANCIAL, Swan River

Grand Champion Gelding

LISA'S GROOMING, Swan River

Cross Rail Hunter – Plaque

SUPER 8 MOTEL Swan River

Grand Champion Stallion-Trophy

Urban Construction, Swan River

Open Junior, PeeWee Command Class,

Senior Command Class

NORTHERN SPECIALTIES TIM-BR MART, Swan River

High Point Gymkhana

TD CANADA TRUST Swan River

High Point Gymkhana

BAR-LYNN STABLES, Lynn & Katie Jo Stehr

PeeWee High Point

COOK & COOKE INSURANCE/FINANCIAL,

Junior High Point

OK TIRE- Swan River

Senior High Point

Stake Class Donors:

RICHARDSON PIONEER

Open Barrel Stake

Porter, Lincoln, & Dehlia Atkinson, Swan River

Senior Western Pleasure Stake

MARY SNELGROVE, Swan River

Junior and PeeWee Western Pleasure Stake

Urban Construction, Swan River

PeeWee Trail Stake

A & W, Swan River

Senior Trail Stake

PAULL FUNERAL HOME, Swan River

Junior Trail Stake

ACE HARDWARE, Swan River

Senior English Pleasure Stake

NORTHERN SPECIALTIES TIM-BR MART, Swan

River

Junior and PeeWee English Pleasure Stake

CAROLYLE FARMS

Open Jumper Stake

DENNIS HIGHMOOR, Swan River

Open Reining Stake

Ag Shield, Benito, MB.

Open Pole Stake

JONES FAMILY

Low Hunter Stake

OK TIRE

Family Riding Class Stake

CASH DONORS

Ten Hsiang Gardens Restaurant

Ferriss Law

SWAN VALLEY VETERINARY CLINIC, Swan River

In Memory of Dr. Rex Leach

- *Senior High Point English*
- *Junior High Point English*
- *PeeWee High Point English*



NORTHWEST ROUNDUP & EXHIBITION
OBJECTIVE OF THE SWAN RIVER VALLEY AGRICULTURAL SOCIETY

THE OBJECTS OF THE AGRICULTURAL SOCIETY ARE FOR THE GOOD OF THE COUNTRY AND OUR PEOPLE TO ORGANIZE AND CONDUCT EXHIBITIONS FOR:

- (a) The promotion of practical and scientific husbandry in all its varying branches.
- (b) The improvements of the types of horses, cattle, sheep, swine, goats and other farm and domestic animals.
- (c) The development of industrial resources of the country.
- (d) The dissemination of mechanical and scientific knowledge.
- (e) The encouragement of the cultivation of the beauty in nature and arts.
- (f) The stimulation of healthy rivalry for supremacy and excellence in the minds of the rising generation.
- (g) The promotion of trade and commerce.

RULES AND REGULATIONS

NOTE: Prizes will be paid Pro rata on the basis of this prize list after the expenses of the fair are paid.

1. All entries must be made on the printed form accompanying the prize list. These forms are to be completed and signed by the exhibitor.
2. Where there are less than two exhibitors in a class, this class may be combined with another class.
3. The secretary will not be responsible for errors received over the phone.
4. **Stock must be on the grounds not later than noon on the first day of the show, and by 8am on Saturday and Sunday.** No stock will be allowed to compete as purebred unless a proper pedigree is produced or the registration number entered on the form. Every exhibit must be entered in the name of the owner.
5. No animal suffering from any infections or contagious disease shall be admitted to the fair grounds.
6. Where purebred animals compete with grades, breeding shall not be considered in awarding prizes.
7. The judges may recommend exhibit not on the prize list and directors may take the matter into consideration and award diploma or special prize where they think the prize worthy.
8. No animal or article will be allowed to compete in more than one class, except for diploma or special prizes.
9. The directors will take every precaution under the circumstances to insure the safety of articles brought to the exhibition and should an article by accident be injured, lost or stolen, they will give all assistance in their power towards recovery of the same, but will not make payment for the value thereof.
10. A meeting of the directors will be held (notice of which will be given) to hear and decide complaints or grievances that may arise in awarding prizes. Protests must be made in writing on day of the show and must be accompanied by a deposit of \$20.00, which will be forfeited if the protest is not sustained.
11. PRIZE MONEY PAID BY CHEQUE BY MAIL.
12. No person shall be allowed to use abusive language or to interfere with the judge in the discharge of his or her duties. Exhibitors so interfering will forfeit their rights to any premium to which they might otherwise be entitled.
13. In placing animals in the show ring, the judge is instructed to place according to merit regardless of competition.
14. All exhibits must be owned by the exhibitor at least thirty days before the fair. No prize will be awarded to any unsound animals. Exhibitors may have advice from judge as to classifying exhibits.
15. No visitors to the fair grounds of the Society nor any person or persons, firms or corporation, or their agents, representing any license and /or employees, having, holding, or enjoying any license or privilege to exhibit at any time on the fair grounds of the society or occupying any space thereon for exhibition or any other purpose or purposes, shall have any claim, or right to claim for damages arising from, or as a result of an injury or injuries to any person, or to any persons, or to any property, while on the fair grounds of the society, nor shall any claim or demand in respect thereof be instituted or maintained.
16. If any damage, loss or injury to persons shall be caused by reason of any neglect or willful act of any person, firm or corporation, or their agents, representative, servants, or employees, having license or privilege to exhibit on said fairgrounds or occupying space thereon, the Swan River Valley Agricultural Society shall in no manner be responsible thereof and in the case it be subjected to any expense or liabilities, all persons causing or liable thereof shall indemnify the said society.

17. A fee of \$30.00 +G.S.T. (non-electrical), \$50.00 + G.S.T. (Electrical), will be charged to exhibitors who park trailers, campers, mobile homes, etc. on the fairgrounds during the fair. All persons paying this fee will be issued a windshield sticker, which must be displayed on the vehicle.
18. **Town bylaw 27/87 is followed concerning pets.**
All dogs and other animals shall if removed from the owner's property, be on a leash or be sufficiently trained that it is under the direct and adequate supervision of the owner or his or her authorized representative. All VEHICLES WITHOUT A VEHICLE PASS WILL BE TOWED AWAY AT OWNERS EXPENSE.
19. All exhibitors are required to pay a \$10.00 administration fee per person.
20. **All entry fees \$3.00 unless otherwise stated.**
21. All exhibitors in riding classes must provide saddles and bridles.
22. All riders, drivers, and attendants, etc. must be neatly and suitable dressed on entering the ring.
23. The judge may send any horse from the ring for bad behavior or lameness. Only attendants are allowed in the ring during judging.
24. On making entry the owner assumes all liability on account of accidents to either horse or rider or property and releases the Swan River Valley Agricultural Society from all responsibility.
25. In Classes 3, 7, & 8, registration may be required.
26. **Stabling and accommodations will be at the discretion of the grounds committee and every attempt will be made to provide facilities. Box stalls are limited so horses MUST be able to tie safely in a tie stall.**
27. In all events where age is stated, contestants will be obliged to furnish proof of age if a dispute on this point should rise.
28. LOCAL refers to the residents of the Municipality of Swan Valley West and Minitonas-Bowsman, and the Local Government District of Mountain and all the towns and villages therein. Local refers to horse and handler.
29. **No Class entry fee shall be refunded except as verified by a veterinarian or doctor. In lieu of refund competitor may choose to substitute their horse up to one hour prior to class. Substitution will count as a new horse/rider combination. Withdrawn horse may not re-enter.**
30. Any horse not entered in the prize list is not eligible for a stall.
31. **Number system will be used. Numbers must be worn on the back of all contestants while in the ring. If numbers are used on the saddle pad, then there must be numbers on BOTH sides. If they are of a HAND DRAWN nature, they must be clear and legible. Numbers allotted to each light horse upon entry. Incorrect numbers or no numbers will be disqualified**
32. The show committee reserves the right to test for any medication, drug, or mechanical device administered internally or externally to a horse before or during any event and upon discovery of such, have the right to disqualify that horse from competition.
33. No cross entry between pony and horse classes except as noted.
NO PONIES IN HORSE CLASSES
34. Every adult contestant must purchase a \$35.00 bracelet. 12 years and under \$25.00 bracelet. This bracelet permits you to activities on the grounds and admission to all Friday, Saturday and Sunday grandstand performances. This bracelet does not include Arena dances, Thursday Night Grandstand or Midway Rides. Any contestant under the age of 18 may purchase one "**Parent or Guardian**" Helper Pass. Any contestant entering 3 or more horses may purchase 1 helper pass for \$35.00. (6 horses =2 helper passes) etc. Bracelet must be put on at the administration office.
35. Stallions, 2 years and over must be shown by a person 18 years and over.
36. **Entries close 5:00 P.M., Friday July 21, 2023.**
Entries must be in the hands of the secretary at this time. If mail service is not fast enough, please email. WE WILL NOT TAKE NEW ENTRIES AFTER THE FRIDAY DEADLINE. **FEES MUST ACCOMPANY ENTRIES.**
37. Coggins Test is not mandatory, though we recommend that each horse be tested.
38. Junior drivers under 14 years of age must be accompanied in the carriage by a knowledgeable adult.
39. All driving classes will be run by Equine Canada (CEF) Section C Rules except junior age designations. (See Page 3).
40. In the Gymkhana events, all hats/helmets must be on your person when you cross the finish line or disqualified. (If hat/helmet hits the ground the rider is disqualified.)
41. In the Gymkhana Events a horse may be ridden by only one rider per event. (Barrels, poles, keyhole, ribbon, stake race).

42. In Gymkhana events for safety reasons all exhibitors must enter through the **IN** gate and exit through the **OUT** gate or be disqualified.
43. In the Gymkhana events, the order of go will be posted. Competitors will have 30 seconds to start the pattern after their names are announced. **NO LEADING OF HORSES/PONIES PAST THE START LINE.**
44. Gymkhana participants must enter on the east side of the track and park on the North side of the infield. Signs will be posted. No parking on the track.
45. There will be a three-minute time limit from the time the class is called to the closing of the gate. After the gate has closed no one will be allowed in. There will be no exceptions.
46. NO SOLICITING ON THE GROUNDS
47. Stalls must be cleaned prior to leaving. A \$20.00 refundable stall-cleaning fee must be submitted by separate cheque. Cheque will be returned if stall is cleaned to the satisfaction of the Light Horse Committee
48. **Patterns and entries will be posted on a board at the end of show ring. It is the responsibility of the competitor to check their entries prior to the show and advise of any errors.**
49. ***The wearing of helmets for competitors in Peewee, Mini and Junior classes and practice areas is mandatory. Any competitors or individuals under the age of 18 as of January 1 of the current year must wear approved ASTM/SEI or BSI/BS EN protective headgear in all events and while on the grounds. Any competitor may wear protective headgear in any division or class without penalty from the judge.***

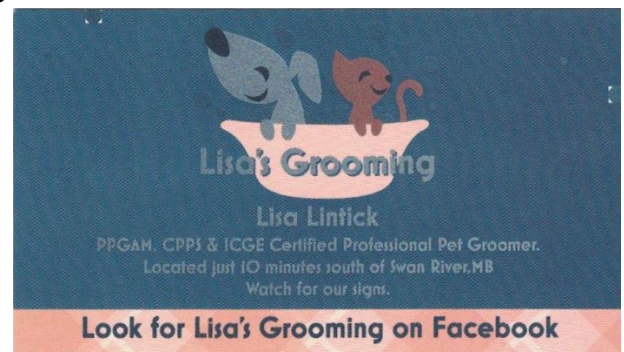

ALL ENTRIES CLOSE FRIDAY, JULY 21, 2023 AT 5:00 P.M.

NOTICE TO ALL EXHIBITORS

ALL ANIMALS ENTERED IN THE LIGHT HORSE SHOW MUST BE ON THE GROUNDS BY 12 NOON FRIDAY AND BY 8:00 A.M. ON SATURDAY AND SUNDAY. EXHIBITORS MAY LEAVE ONLY AFTER 8:00 P.M. ON FRIDAY AND SATURDAY AND 5:00 P.M. ON SUNDAY UNLESS BY SPECIAL PERMISSION.

JUDGING TIMES - ALL TIMES ARE C.S.T.

LIGHT HORSE SHOW

Friday, July 28- 1:00 P.M. Show Ring
 Saturday July 29- 8:00 A.M. Grandstand Saturday July 29-1:00 P.M. Show Ring
 Sunday July 30- 9:00 A.M. Show Ring

All Exhibitors should be familiar with Equine Canada (CEF) Rules.

IN CASE OF AGE CATEGORY CONFLICT-LOCAL AGE RULES SHALL PREVAIL

2023 JUDGE

Julia Keil-Quibell - Melfort, SK.

AGE CATEGORIES

Exhibitor is responsible for entering in right age category or is disqualified from the classes.

SENIOR- *Any athlete who is 19 years or older as of January 1st of the Current Year.*

JUNIOR- *Athletes between 13 and 18 years of age as of January 1st of the Current Year.*

PEEWEE- *Athletes who are 12 years and under as of January 1st of the Current Year.*

MINI – *Athletes who are 6 years and under as of January 1 of the Current Year.*

DEFINITIONS

HUNTERS are to be judged on an even hunter pace, manners, and way of going and style of jumping.

JUMPERS are to be scored on faults accumulated with a jump-off to break a first place tie.

YELD MARE- One that has not produced a foal in the current year and is not visibly in foal at the time of exhibition.

BROOD MARE- one that has produced a foal in the current year or is visibly in foal at the time of exhibition.

JUNIOR HORSE- 5 years and under

SENIOR HORSE- 6 years and over

HOBBY STICK HORSE

6 Years and under. Ring Side entry. No Entry Fee

Bring Your Own Stick Horse

HORSE & RIDER OPEN PARADE GLAMOUR

Sponsored by LLOYD'S JEWELLERS

Judging will be as follows: Fifty percent manners & suitability, fifty percent equipment and personal attire.

1st- \$50.00

2nd- \$30.00

3rd- \$20.00

Must register prior to parade with Chamber of Commerce Office at 734-3102

Judging will take place at 9:45 at Formo Motors

RANCH RIDING – PATTERN 3

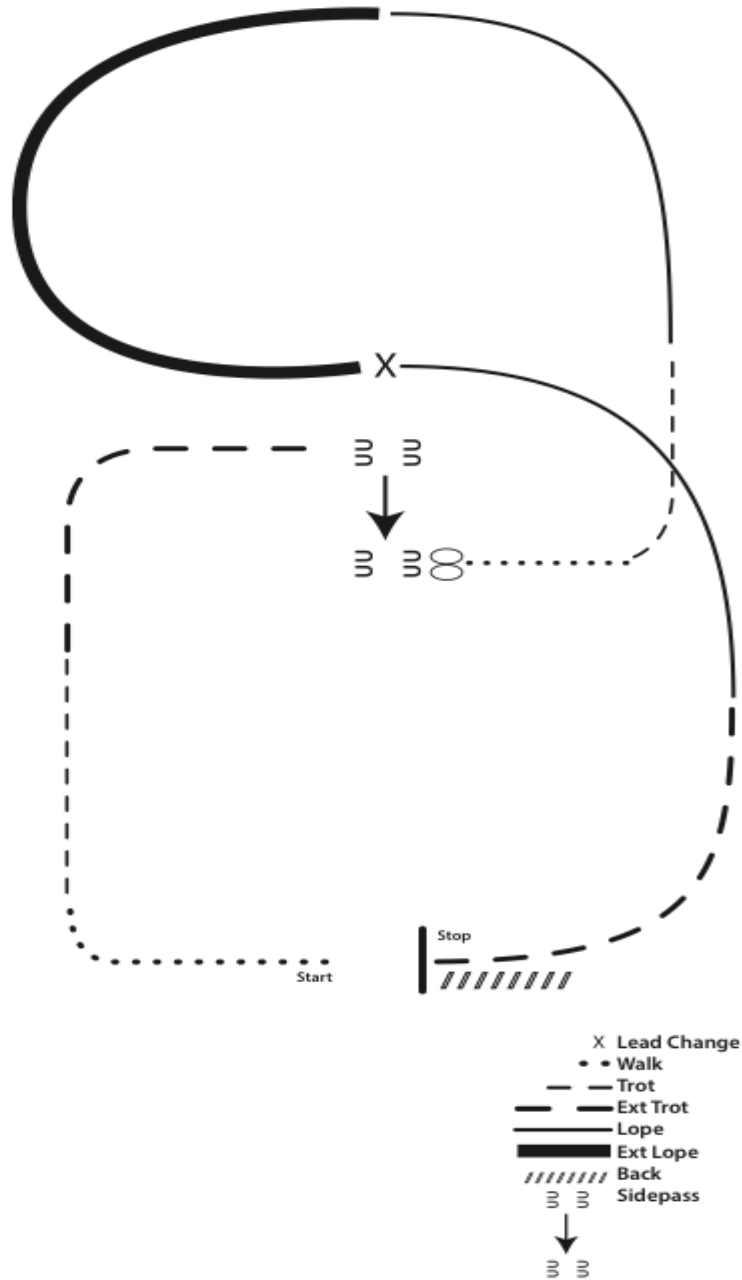

1. Walk to the left around corner of the arena
2. Trot
3. Extend alongside of the arena and around the corner to center
4. Stop, side pass right
5. 360 degree turn each direction (either way 1st)
6. Walk
7. Trot
8. Lope left lead
9. Extend the lope
10. Change leads (simple or flying)
11. Collect to the lope
12. Extend Trot
13. Stop and back

SWAN VALLEY VETERINARY CLINIC

Box 388 Swan River, MB R0L 1Z0

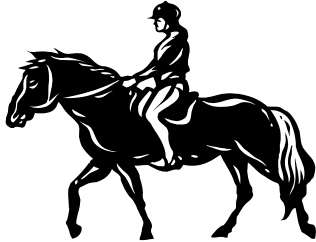

Phone: (204)734-4565

Fax: (204) 734-9530

Email:svvc@mts.net

Dr. K. Immerkar

Dr. Lana Tokar

Dr. Matt Strate

Dr. E. Brandson

**Special Veterinary
Diagnostic Equipment
Blood Analysis - Ultrasound
X-Rays - Endoscopy**

JOURNEY ONWARD.

**FREE WI-FI. FREE BREAKFAST.
IN-ROOM FRIDGE & COFFEE.**

SUPER 8 SWAN VALLEY
115 Kelsey Trail
Swan River, MB R0L 1Z0
204.734.7888
info@swanvalleysuper8.com



MEMBER OF
WYNDHAM
REWARDSSM

© 2017 Super 8 Worldwide, Inc. All rights reserved. All Super 8 hotels are independently owned and operated.



Swan Valley
CO-OP

You're at home here.

204.734.3431

www.swanvalleycoop.ca

FEATURE CLASSES

21 FEATURE CLASSES WILL BE RANDOMLY
SELECTED TO RECEIVE

DOUBLE THE PRIZE MONEY

FOR 1ST, 2ND AND 3RD PLACINGS.

***\$1100.00
IN ADDED
PRIZE
MONEY!***

**NO STALL
FEES!**

BUT, YOU WON'T KNOW WHICH
CLASSES THEY ARE UNTIL THE
TIME OF THE SHOW!

So, Bring More Horses. Enter More Classes. Tell Your Friends!

REINING STAKE PATTERN

PATTERN 8

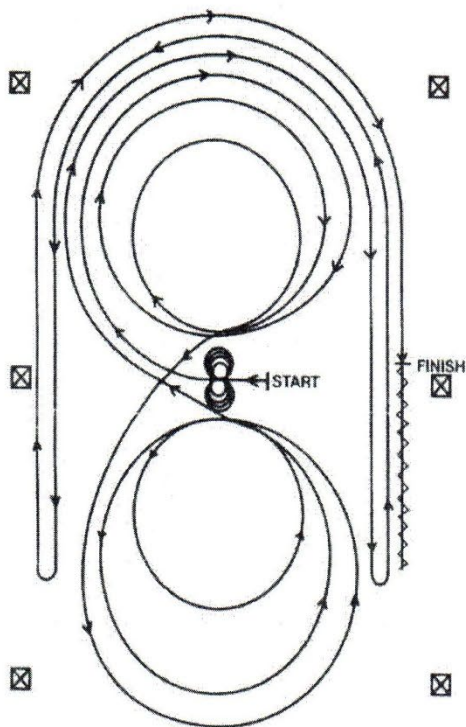

PATTERN 8

Horses may walk or trot to the centre of arena.

Horses must walk or stop prior to starting pattern. Beginning at the centre of the arena facing the left wall or fence.

1. Complete four spins to the left.
2. Complete four spins to the right. Hesitate.
3. Beginning on the right lead, complete three circles to the right: the first circle large and fast, the second circle small and slow; the third circle large and fast. Change leads at the centre of the arena.
4. Complete three circles to the left: the first circle large and fast; the second circle small and slow; the third circle large and fast. Change leads at the centre of the arena.
5. Begin a large fast circle to the right but do not close this circle. Run straight down the right side of the arena past the center marker and do a left rollback at least twenty feet from the wall or fence - no hesitation.
6. Continue back around the previous circle but do not close this circle. Run down the left side of the arena past the center marker and do a right rollback at least twenty feet from the wall or fence - no hesitation.
7. Continue back around the previous circle but do not close this circle. Run down the right side of the arena past the center marker and do a sliding stop at least twenty feet from the wall or fence. Back up at least ten feet. Hesitate to demonstrate completion of the pattern.

Upon completion of pattern, riders must acknowledge judge and promptly exit arena. (Judge MAY request removal of bridal).

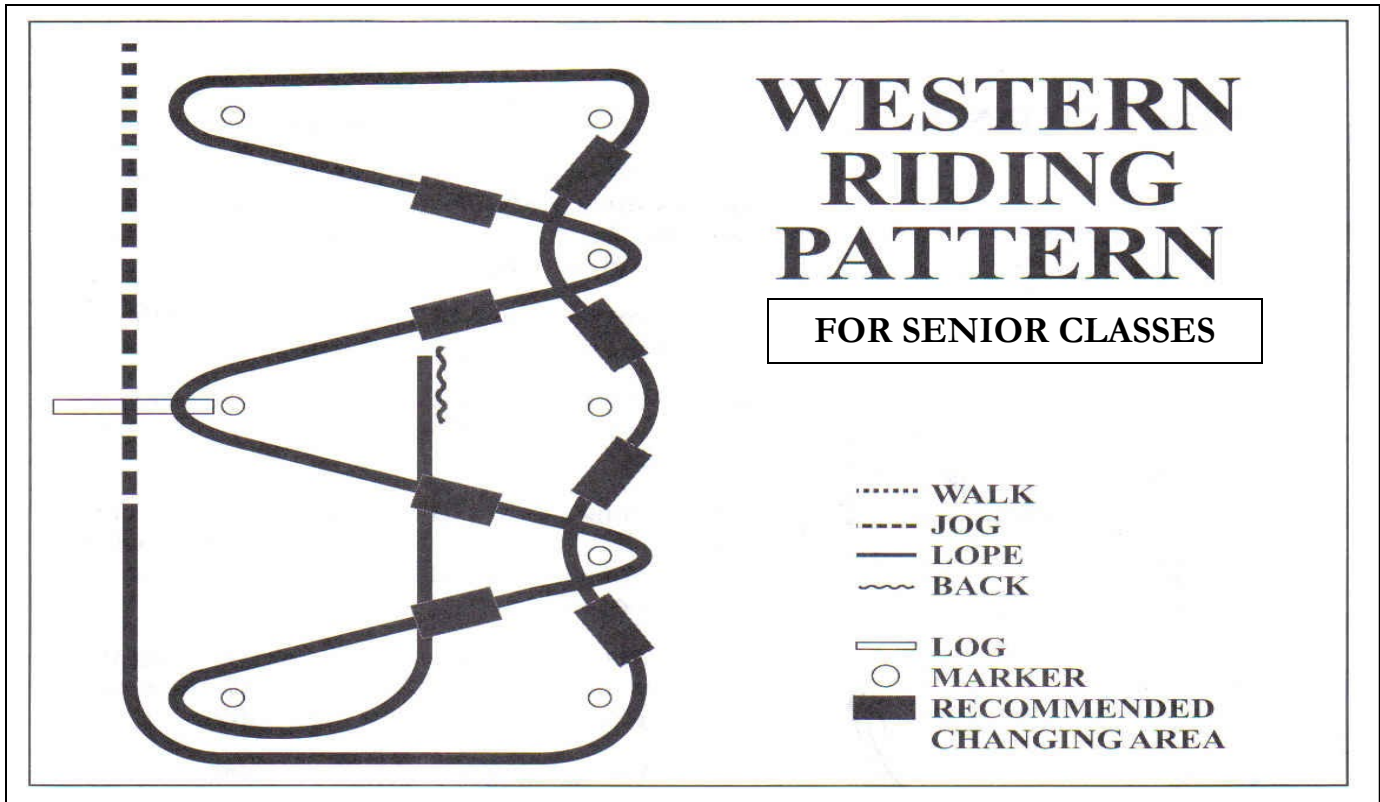

Cook & Cooke

INSURANCE / FINANCIAL



SWAN RIVER- THE PAS

Senior Reining Pattern

PATTERN

2

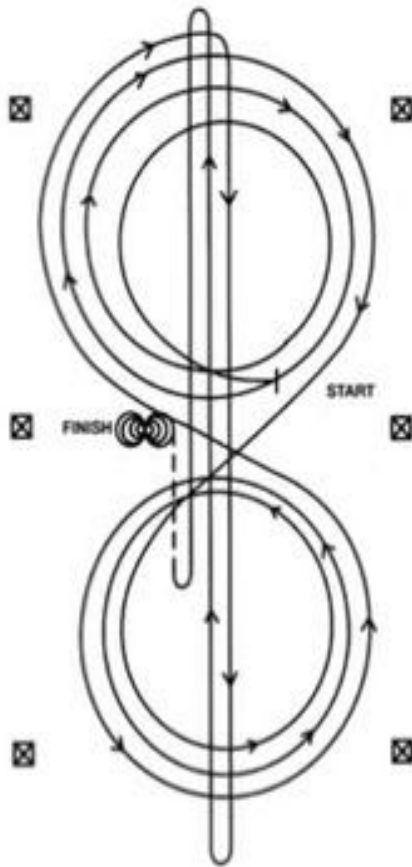

PATTERN

2

Horses may walk or trot to the center of arena. Horses must walk or stop prior to starting pattern. Beginning at the center of the arena facing the left wall or fence.

1. Beginning on the right lead, complete three circles to the right: the first circle small and slow; the next two circles large and fast. Change leads at the center of the arena.
2. Complete three circles to the left: the first circle small and slow; the next two circles large and fast. Change leads at the center of the arena.
3. Continue around previous circle to the right. At the top of the circle, run down the middle to the far end of the arena past the end marker and do a right rollback – no hesitation.
4. Run up the middle to the opposite end of the arena past the end marker and do a left rollback – no hesitation.
5. Run past the center marker and do a sliding stop. Back up to the center of the arena or at least ten feet (three meters). Hesitate.
6. Complete four spins to the right. Hesitate.
7. Complete four spins to the left. Hesitate to demonstrate the completion of the pattern.

Rider must dismount and drop bridle to the designated judge.

PEE WEE REINING PATTERN

Horses may walk or trot to the center of the arena. Horses must walk or stop prior to starting the pattern. Beginning at the center of the arena facing the left wall or fence.

1. Beginning on the left lead, complete two circles to the left. Stop at the center of the arena. Hesitate.
2. Complete two spins to the left. Hesitate
3. Beginning on the right lead complete two circles to the right. Stop at the center of the arena. Hesitate.
4. Complete two spins to the right. Hesitate.
5. Beginning on the left lead, go around the end of the arena, run down the right side of the arena past center marker, stop and roll back right.
6. Continue around the end of the arena to run down the left side of the arena past the center marker. Stop. Back up.

Hesitate to show completion of pattern.

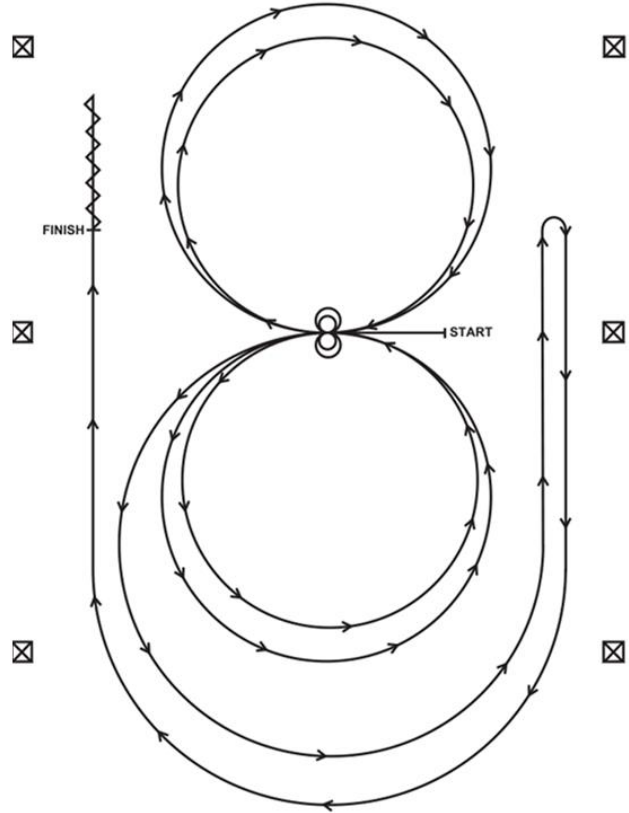

PEE WEE/JUNIOR

WESTERN RIDING PATTERN

1. Walk at least 15' & jog over log
2. Transition to left lead & lope around end
3. First line change
4. Second line change lope around the end of arena
5. First crossing change
6. Second crossing change
7. Lope over log
8. Third crossing change
9. Fourth crossing change
10. Lope up the center, stop & back

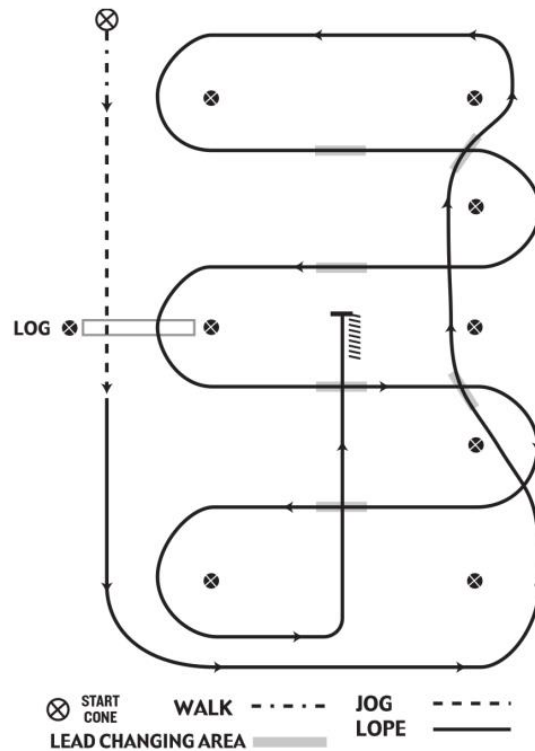

2023 LIGHT HORSE SHOW CLASSIFICATIONS

ENTER FROM HERE

All entries \$3.00 each, Stake classes \$10.00 each

Coordinators: Dennis Highmoor, Lynn Stehr, Karen Medwid, Nancy Jones, Carolyn Lumax, Marsha Hrycyk, Angela Mullin, Daphne Currie, Melanie McArthur

PRIZE MONEY: 1st- \$20, 2nd- \$17, 3rd- \$14, 4th- \$11

STAKE CLASSES - \$100.00 plus \$60.00 prize money plus \$10.00 entry fee added to stake and divided as follows: 30% 25% 20% 15% 10%.

FRIDAY, JULY 28, 2023 1:00 P.M.

***HEAVY HORSE CLASSES MAY BE SHARING THE RING AT VARIOUS TIMES THROUGHOUT THE SHOW. ***

1. Light Horse, 1 & 2 year old Filly
2. Light Horse, 1 & 2 year old Gelding
3. Light Horse, 1 & 2 Year old Stallion, registered
4. Yield Mare, 3 yrs old or over western type
5. Yield Mare, or gelding, 3 yrs or over English \ harness type
6. Gelding, 3 yrs & over, western type
7. Stallion any light Breed, registered 3 yrs & over.
8. Get of Sire and Progeny of Dam. Two or more horses, any age any sex, sired by same stallion. Proof of breeding in writing required. Joint ownership permissible. Progeny of Dam- two or more horses, any age, any sex, produced by same dam, joint ownership permissible. Dam must be named.
9. Champion and Reserve Champion Mare or Filly. 1st and 2nd winner of class 1, 4, 5 are eligible. Sponsored by **PNB STOCK FARM**. Ribbon for Champion. Ribbon for Reserve.
10. Champion and Reserve Champion Gelding. 1st & 2nd placing in classes 2, 5, 6 are eligible. Sponsored by **COOK & COOKE INSURANCE/FINANCIAL**. Ribbon for Champion. Ribbon for Reserve
11. Grand Champion & Reserve Champion Stallion. 1st & 2nd placing in Classes 3 and 7 are eligible. Trophy and Ribbon for Champion. Ribbon for Reserve. Sponsored by: **SUPER 8 MOTEL**
12. Pony, filly, gelding, or stallion, 1 & 2 years old.
13. Pony Yield Mare or gelding, 3 years and over
14. Pony Stallion, 3 years and over.
15. Champion Pony on Halter. 1st and 2nd place winners of classes 12, 13, 14. Trophy sponsored by **SWAN RIVER ELKS CLUB**. Trophy and Ribbon for Champion. Ribbon for Reserve.
16. Mini Showmanship- Exhibitors 6 yrs. & under. Cannot cross enter with Pee Wee Showmanship.
17. JUNIOR Showmanship
18. PeeWee Showmanship
19. PeeWee Local Showmanship- to be shown on halter. Grooming & dress considered.
20. SENIOR Showmanship

20 MINUTE BREAK, START TIME WILL BE ANNOUNCED

21. Novelty Costume. Judging will be as follows: 50% on Manners and suitability of horse, 50% on equipment and personal attire.
Trophy. Sponsored by **SWAN WOOD SHAVINGS INC.**
22. Walk and Trot. 10 Years and under. Cannot cross enter to any other equitation class. Gift

- 23. Hobby Stick Horse Class- 6 Years and under Ringside entry. No Entry Fee Bring your own stick horse**
- 24. Combination Horse or Pony- English to Western. Riders must enter the ring fitted in English attire and tack and will be judged accordingly. A quick tack and clothing change shall be done in the ring to Western attire and will once again be judged. Each competitor will be allowed one helper.**
- 25. JUNIOR Reining. Pattern on page 12.**
- 26. PEEWEE Reining. Pattern on page 12.**
- 27. SENIOR Trail Stake. Sponsored by A & W**
- 28. JUNIOR Trail Stake. Sponsored by PAULL'S FUNERAL HOME**
- 29. PEEWEE Trail Stake. Sponsored by URBAN CONSTRUCTION**

Faith's Equine Sport Therapy

Certified Equine Therapist

Specializing in Movement, Structure Alignment, and Massage



204.539.2409 (H)

204.281.3284 (C)

“Body Maintenance for your Equine Athlete”

SATURDAY, JULY 29 8:00 A.M.

GRANDSTAND

Western Speed Events Division\Gymkhana

All Exhibitors entering only gymkhana classes must enter on the east side of the track and park on the North side of the infield. Signs will be posted. **NO PARKING ON THE TRACK.**

Failure to comply with the above shall result in disqualification.

ALL HATS/HELMETS MUST BE ON YOUR PERSON WHEN YOU CROSS THE FINISH LINE OR DISQUALIFIED. (If hat/helmet hits the ground the rider is disqualified.)

For safety reasons competitors must enter through the **IN** gate and exit through the **OUT** gate or be disqualified.

In the Gymkhana events, the order of go will be posted. Competitors will have **30 seconds** to start the pattern after their names have been called. **Failure to do so will result in disqualification.**

NO LEADING OF HORSES/PONIES PAST THE START LINE.

All competitor packages must be picked up from the office **by 6:00 P.M. on Friday.** (There will be no one in the office prior to the start of Gymkhana events.)

A HORSE MAY BE RIDDEN BY ONLY ONE RIDER PER EVENT

(E.g. Barrels, keyhole, ribbon race, stake race etc.)

30. SENIOR Barrel Race.
31. JUNIOR Barrel Race
32. PEEWEE Barrel Race.
33. OPEN Barrel Stake. Sponsored by **RICHARDSON PIONEER**
34. SENIOR Pole Bending.
35. JUNIOR Pole Bending
36. PEEWEE Pole Bending
37. OPEN Pole Stake. Sponsored by **SHARON FOSTER FAMILY**
38. SENIOR Keyhole Race.
39. JUNIOR Keyhole Race.
40. PEEWEE Keyhole Race
41. SENIOR Stake Race.
42. JUNIOR Stake Race.
43. PEEWEE Stake Race.
44. OPEN JUNIOR or PEEWEE Ribbon Race. Contestants may only compete once.
45. SENIOR Ribbon Race. Contestants may only compete once.

Presentation of ribbons will take place in the waiting area after each event is run.

Presentation of High Point Gymkhana Awards

will take place at the Light Horse ring before afternoon show begins.

Results will be posted at approx. 12:45 p.m.

Presentation of High Point Gymkhana Awards Sponsored by:
NORTHERN SPECIALTIES TIM-BR MART & TD CANADA TRUST

Classes that Qualify for Gymkhana High Point are:

Pee Wee-32, 36, 40 Junior- 31, 35, 39 Senior- 30, 34, 38

SATURDAY 1:00 P.M

Presentation of Gymkhana High Point

- 46. Lead Line, 6 years and under, must enter in rider's name.
- 47. Beginning Hunter, no combinations, Maximum height 2'0"
- 48. Low Hunter Stake. No Combinations. Maximum height 2'3". Sponsored by **JONES FAMILY**

*Hunter/Jumper horses may enter from either:

Group A (classes 49 & 50) or Group B (Classes 46, 47, 70, 71, 72, 73)

Hunter distances will be calculated on an 11-foot stride.

EG: Horse/rider combo who enters Group A (Class 49 & 50) may not enter Group B (Classes 46, 47, 70, 71, 72 & 73)

- 49. Cross Rail Hunter. No combinations. Maximum 18 inches.
- 50. Cross Rail Hunter. Maximum 24 inches Horse/rider combo cannot enter with any other jumping classes. Plaque by **LISA'S GROOMING for High Point of #49 & 50**
There will be a 10-minute break for Warm-Up before starting Class 51
- 51. Show Hack. Horses to be shown at a walk, trot, canter, and hand gallop. Extended and collected gaits to be called for. To be judged on performance, quality, conformation, and manners. Only 8 horses to gallop at one time. Martingales and breastplates not allowed. **NO PONIES**

- 52. Saddle Pony 14.2 hands and under. Western or English Equipment
- 53. Senior English Pleasure
- 54. PeeWee English Pleasure
- 55. Junior English Pleasure
- 56. PeeWee English Equitation
- 57. Junior English Equitation
- 58. SENIOR Western Pleasure.
- 59. PeeWee Western Pleasure
- 60. Western Pleasure Horse, 6 years and older.
- 61. Local Saddle Horse or Pony- Western Equipment. Horse and Rider to be Local.
Sponsored by **COOK & COOKE INSURANCE/FINANCIAL**
- 62. Family Riding Class Stake, open to three or more members of a family (1 paid contestant only), if a rider is under 10 years of age, a lead rope may be used. Contestants walk or trot only, Equipment Optional. Sponsored by: **OK TIRE**
- 63. Western Pleasure Horse 5 Years and under.
- 64. Pair of Driving Horses or ponies.
- 65. JUNIOR Western Pleasure
- 66. Pleasure Driving Pair, Horses or Ponies
- 67. Saddle Pairs – Western Equipment. Joint ownership Permissible
- 68. Single Pleasure Driving Horse or Pony hitched to a suitable vehicle. To be shown at a walk, slow trot, working trot, and strong trot.
- 69. OPEN JUNIOR or PEEWEE Pleasure Driving (Please state Driver's name)
- 70. Combination Horse or Pony to be shown in harness to a suitable vehicle, then to be shown under saddle. To be judged on suitability for saddle and harness work. One helper allowed. Same rider/driver.
- 71. **OPEN JUNIOR or PEEWEE "COMMAND CLASS"** Sponsored by: **Urban Construction**

72. SENIOR "COMMAND CLASS" Sponsored by: Urban Construction

English & Western disciplines, come join us in a fun "wrap-up" to Saturday with our "Command Class" event. Similar to "Simon Says", but on horseback. Those that do not complete the action to the judges' satisfaction will be eliminated. Winner will be presented a prize sponsored by **Urban Construction**.



SWAN VALLEY PHARMACY

At the Swan Valley Co-op

811 Main St E, Swan River, MB
swanvalleypharmacy@gmail.com

204-734-2882 (phone)
204-734-6360 (fax)

Jeffrey Leadbeater, B.Sc.Pharm., CDE

Arla Wittmier, B.Sc.Pharm.

Rachele Anderson, B.Sc.Pharm.

WE FILL YOUR PRESCRIPTION WILL YOU SHOP



SWAN WOOD SHAVINGS INC.

**Kiln Dried Screened Softwood Shavings
The Perfect Animal Bedding**

204-734-3089

Swan River, MB R0L1Z0

Box 1210

SUNDAY, JULY 30 9:00 A.M.

In Jumping Classes there will be no jump offs. All rounds will be timed.

- 73. Low Jumper- may include combination and some hunter fill. Maximum height 2'.
- 74. Training Jumper. Maximum Height 2'3".
- 75. OPEN Jumper Stake. Maximum 2'3". Sponsored by: **CAROLYLE FARMS, SWAN RIVER**
- 76. Joker Poker.

JOKER POKER

*Each Jump has a value. Contestants have one minute to jump the course. They may jump the course any direction they wish but can only jump any specific jump twice. They do not have to jump all the obstacles. When the whistle blows to end the minute ride, the contestant then has the option of jumping the **JOKER** jump, which is worth 100 points. If they make it, the 100 points is added to their score and if they knock it down, 100 points will be deducted from their score. Placing's are determined by most points accumulated.*

There will be a 10-minute Warm-Up before starting Class 77

- 77. Road Hack. Horses to be shown at a flatfooted walk with reasonably loose rein, trot, strong trot, easy canter, and hand gallop. To be judged on performance, conformation, substance, and manners. Only 8 horses to gallop at one time. Martingales and breastplates not allowed.

NO PONIES.

- 78. OPEN JUNIOR or PEEWEE English Pleasure Stake. Sponsored by: **NORTHERN SPECIALTIES TIM-BR MART**

- 79. PEEWEE Local Equitation **English or Western Equipment.**

- 80. SENIOR English Pleasure Stake. Sponsored by: **ACE HARDWARE**

- 81. SENIOR English Equitation.

- 82. Saddle Pairs, English Equipment Joint Ownership Permissible

There will be a 10 min Warm-Up before the starting of Class 83.

- 83. PEEWEE Western Equitation.

- 84. JUNIOR Western Equitation.

- 85. SENIOR Western Equitation.

- 86. JUNIOR Western Riding. Pattern on page 12.

- 87. Senior Western Riding. Pattern on page 10.

- 88. PEEWEE Western Riding. Pattern on page 12.

- 89. OPEN Single Pleasure Driving Horse or Pony.

- 90. OPEN Reinsmanship. To be driven at a walk, slow trot, working trot and strong trot. May be asked to do individual work. Open to juniors and seniors, horses and ponies, singles and pairs. To be judged 75% on handling of reins and whip, control, posture and overall appearance of driver. 25% on the condition of harness and vehicle and neatness of attire.

- 91. SENIOR Western Pleasure Stake. Sponsored by **PORTER, LINCOLN, & DEHLIA ATKINSON**

- 92. OPEN JUNIOR or PEEWEE Western Pleasure Stake. Sponsored by: **MARY SNELGROVE**

- 93. Senior Reining. Pattern 2 page 11

- 94. OPEN Reining Stake. Pattern 8 on page 9. Sponsored by **DENNIS HIGHMOOR**

- 95. Junior Ranch Riding. Pattern on page 6.

- 96. PeeWee Ranch Riding. Pattern on page 6.

- 97. Senior Ranch Riding. Pattern on page 6.

CLASSES THAT QUALIFY FOR HIGH POINT

PEE WEE ENGLISH- 47, 49, 50, 51, 54, 56, 73, 74, 77

JUNIOR ENGLISH- 47, 49, 50, 51, 55, 57, 73, 74, 77

SENIOR ENGLISH- 47, 49, 50, 51, 53, 73, 74, 77, 81

- Presentation of **English High Point Awards** -Peewee, Junior & Senior,
Sponsored by: **SWAN VALLEY VETERINARY CLINIC**

PEEWEE WESTERN-18, 26, 29, 59, 83, 88, 96

JUNIOR WESTERN- 17, 25, 28, 65, 84, 86, 95

SENIOR WESTERN- 20, 27, 58, 85, 87, 93, 97

- Presentation of **Peewee High Point Award** Sponsored by: **BAR-LYNN STABLES**
- Presentation of **Junior High Point Award** Sponsored by: **COOK & COOKE
INSURANCE/FINANCIAL**
- Presentation of **Senior High Point** Sponsored by: **OK TIRE**

All High Point Classes are calculated on Combination Horse and Rider

The following point system will determine the winner:

1st- 5 points 2nd-4 points 3rd- 3 points 4th- 2 points 5th- 1 point

On Sunday 1/2 hour at the end of the class will be allowed to confirm the calculation of points and appeal registered if necessary.

After time allotted, presentations are final.

What is this class all about?

The following are descriptions of the light horse classes to help spectators better understand
What the judge is looking for.

Equine Canada rules over-ride any explanation given in this section.

- **Halter classes** are divided into 2 types: confirmation and showmanship.

- **Confirmation** – This class evaluates the conformation of the horse. Classes are divided by age and sex. Horses are shown on the halter and are traveled before the judge so that lameness and quality of movement can be evaluated. Horses are judged on balance, structural correctness, and breed and sex characteristics. In addition to age and sex divisions, horses may be judged on type and their suitability to a specific application, i.e. saddle type or harness type.

- **Showmanship** – This class is designed to judge the showmanship skills of the exhibitor. The judge evaluates the grooming and fitting of the horse and expertise of the exhibitor in presenting the horse. Each exhibitor is required to perform a pattern designed by the judge with emphasis on preciseness of pattern and degree of confidence exhibited by the showman.

Western classes are conducted in “Western” tack and attire, which is most commonly associated with riding in North America. Classes are divided into 2 types: equitation and performance.

Gaits – The 3 major gaits in western classes are: Walk, Jog and Lope. Horses must also halt and back up.

- **Western Equitation\Stock Seat Eq.** – This class is designed to test the horsemanship abilities of riders using western tack. The class may be divided into 2 sections; riders may first follow a prescribed pattern of maneuvers at a walk, trot or lope. Finalists would then ride as a group around the perimeter of the arena. Judging focuses on the rider’s body position, seat in the saddle and ability to control the horse.

- **There are a wide variety of performance classes**

- **Western Pleasure** – This is one of the most popular show events. Contestants compete simultaneously, traveling the perimeter of the arena, and at the discretion of the judge, are asked to walk, jog, lope and reverse the direction of the horse. Horses are evaluated on quality of movement while staying quiet and calm, traveling on a loose rein. This horse should be “a pleasure” to ride.

- **Western Riding** – This class judges the abilities of the horse to change leads precisely, easily and simultaneously, using both hind and front legs. Following a designated pattern, consisting of a log and a series of pylons, the horse and rider must change gaits (from walk to a jog or a lope) throughout the course. Reward is given to the horse that changes fluidly and precisely between the middle of the pylons within the pattern. Emphasis is placed on smoothness and an even cadence of gaits. The horse should cross the log both at the jog and the lope without breaking gait or radically changing stride.

- **Reining** – This class judges the horse on movements, mastery of a prescribed maneuver and attitude as he is guided through a pattern. The horse is required to perform a number of stops, spins, rollbacks, lead changes and circles at a lope. The horse should be willing to be guided with little or no resistance. Credit is given for smoothness, finesse, attitude, quickness and authority of performing various maneuvers, while using controlled speed. This raises the difficulty level and makes him more exciting and pleasing to watch.

- **Trail** – The trail class tests the maneuverability of a horse through an obstacle course. Mandatory obstacles include one in which the rider will open, pass through and close a gate. Other mandatory obstacles are riding over at least 4 logs or poles and 1 backing obstacle. The judge will assign a point value to each obstacle and points will be added to or subtracted from this score based on the horse's willingness, ease and grace in negotiating the course.

-**Ranch Riding** - The purpose of Ranch Riding should reflect the versatility, attitude, and movement of a working horse. The horse's performance should simulate a horse working outside the confines of an arena and that of a working ranch horse. This class should show the horse's ability to work at a forward, working speed while under control by the rider. Light contact should be rewarded and horse shall not be shown on a full drape of reins. The overall manners and responsiveness of the horse while performing the manoeuvre requirements and the horse's quality of movement are the primary considerations.

Gymkhana \ Western Speed Events Division

- **Barrel Racing** – This is an exciting race against the clock in which exhibitors follow a course consisting of 3 barrels in a triangular "cloverleaf" pattern. Riders choose to circle either the right or left barrel first, race to the opposite barrel and complete the course after circling the third barrel and racing down the center of the 3 barrels to stop the timer. Knocking over a barrel carries a 5 second penalty.

- **Pole Bending** – This is a timed event in which the speed and agility of the horse are tested as horse and rider twice weave through a course of 6 poles spaced 21 feet apart. From the start line exhibitors ride to the farthest pole and weave the length of the poles and then turn and weave back again. They then turn and race to the finish line. The pattern must be followed exactly. A 5 second penalty is added for each pole knocked down.

- **Keyhole** – In this timed event, contestants must travel from the start line to a keyhole shape marked in flour on the ground. Once inside the keyhole the horse must turn or pivot 180° without touching the white lines. Leaving the same way they came in, contestants run to the finish line. If the horse touches or steps over the white line they are disqualified.

- **Ribbon Race** – This race requires coordination and cooperation between team members. The horses must be able to travel side by side even in the turns. Two riders are joined together by a rather short paper ribbon that they hold in their hands. From the starting line the competitors travel down the arena to a barrel. They must go around the barrel and return to the finish line. If they release or tear the ribbon they are disqualified. Knocking over a barrel carries a 5 second penalty. Of course, speed is good, but agility is better.

- **Stake Race** – The official obstacle of the stake Race shall be a pole 6' tall mounted on a 10 to 18 inches diameter base. The correct pattern shall be: run across the center timing line, turning left or right around the stake at that end; return through the center, turn the opposite way around the other stake then sprint back through the center shutting off the timer. Failure to follow the course or knocking down a stake or course marker shall result in elimination.

English classes are conducted in "English" tack and attire, which is most commonly associated with riding in Britain or Europe. Classes are divided into 2 types: equitation and performance.

Gaits – The 3 major gaits in English classes are: Walk, Trot and Canter. Horses must also halt and back up

- **English Equitation** – This class tests the ability to ride, not the performance of the horse. As in western equitation, contestants work a predetermined pattern consisting of maneuvers such as changing gaits, traveling in a figure-8 pattern, backing up as well as posting (rising in the saddle) on the correct diagonal and counter-cantering. Riders are usually judged individually and then return to be judged as they travel the perimeter of the arena performing gait changes at the judge's discretion. Emphasis is placed on ability to sit correctly, hold the correct riding posture and control the horse on a precise pattern.

- There are a wide variety of performance classes

- **English Pleasure** – In this class the judge evaluates a hunter-type horse on the flat, both directions of the arena, at a walk, trot and canter. Emphasis is placed on smoothness of gait, free-flowing stride and willingness to perform.

- **Road Hack** – The road hack is a speedy road horse used under saddle at a flat-footed walk, a trot, road trot, canter and hand gallop. At any time during the class, judges may ask entries to halt and walk off on a loose rein. At the hand gallop, the horse should demonstrate his ability to move out of a rolling three-beat canter by lengthening his stride to a controlled gallop. The resulting increase in speed should be equally consistent on the straightaway and on the turns. Excessive speed shall be penalized. The road hack must stand quietly and back readily.

- **Show Hack** – The outstanding characteristics of the show hack are his grace, elegance and perfect manners. The hack's action must be more spectacular than that of a road hack. The trot should be long and low with the potential to extend and point the toe when asked. The canter should be noted for its balance, smoothness and rhythm. He must be 100% responsive to the rider's aids and be light on the hands. The hack will be required to walk freely on a loose rein, trot elegantly, strike off into a collected canter extending as necessary and come back quietly with no fuss to stand rock-still when asked. He will also be required to back.

- **Hunter** – This event includes several divisions based on the configuration and height of the fences. The class demonstrates the gracefulness of the horse as it maneuvers a course consisting of at least 4 obstacles but must jump a minimum of eight fences (some may be jumped twice). Manners, style of jumping, flow of strides, balance and keeping an even hunter pace are factors in the judge's scoring.

- **Jumper** – Jumping is a test of a horse's athletic ability to perform over fences. Jumping consists of at least 4 obstacles and a minimum of 8 jumps (some may be jumped twice). Scores are based on time and penalty faults. Faults are assessed when a horse refuses to jump, knocks down an obstacle or causes the height of an obstacle to be lowered. Horses completing the course without faults return to compete in a timed "jump off" to determine final placing.

Driving Classes are divided into 2 types: Pleasure and Reinsmanship. Further division may be made between numbers of horses (singles or pairs).

Gaits – The 4 major gaits in pleasure driving are: walk, slow trot, working trot and strong trot. Horses must also halt and rein back.

- **Walk** – A free, regular and unconstrained walk of moderate extension is required. The horses should walk energetically, but calmly, with even and determined pace.

- **Slow Trot** – the horse should maintain forward impulsion while showing submission to the bit. The trot is slower and more collected, but no to the degree required in the dressage collected trot. However, the horse should indicate willingness to be driven on the bit while maintaining a steady cadence.

- **Working Trot** – This is the pace between the strong and the slow trot and more round than the strong trot. The horses go forward freely and straight; engaging the hind legs with good hock action; on a taut, but light, rein; the position being balanced and unconstrained. The steps should be as even as possible. The hind feet touch the ground in the footprints of the fore feet. The degree of energy and impulsion displayed at the working trot denoted clearly the degree of suppleness and balance of the horse.

- **Strong Trot** – This is a clear, but not excessive, increase in pace and lengthening of stride while remaining well balanced and showing appropriate lateral flexion on turns. Light contact to be maintained. Excessive speed will be penalized.

- **Halt** – Horses and vehicle should be brought to a complete square stop without abruptness or veering. At the halt, horses should stand attentive, motionless and straight with the weight evenly distributed over all 4 legs and be ready to move off at the slightest indication from the driver.

- **Rein Back** – Rein back is defined as a backward movement in which the legs are raised and set down simultaneously in diagonal pairs with the hind legs remaining well in line. The horse must move backward at least 4 steps in an unhurried manner with head flexed and straight, pushing the carriage back evenly in a straight line. The driver should use quiet aids and light contact. The horse must then move forward willingly to former position using the same quiet aids.

- **Reinsmanship** – This class is the driven equivalent of ridden equitation and entries are judged primarily on the ability and skill of the driver. Shown at a walk, slow trot, working trot and strong trot, drivers shall also be required to rein back. Exhibitors may be asked to work simultaneously or individually. Individual work may include a figure of 8 and/or other appropriate tests.

- **Pleasure Driving** – In this class entries are judged primarily on the suitability of the horse to provide a peasant drive. The horse is required to pull a suitable 2 or 4 wheeled vehicle along the perimeter of the arena at a walk, slow trot, working trot and strong trot. The horse is judged on straight and free movement, manners and a bright expression while staying under the driver's control at all times. Horses must not break into a canter at any time. Exhibitors may be asked to do individual work.

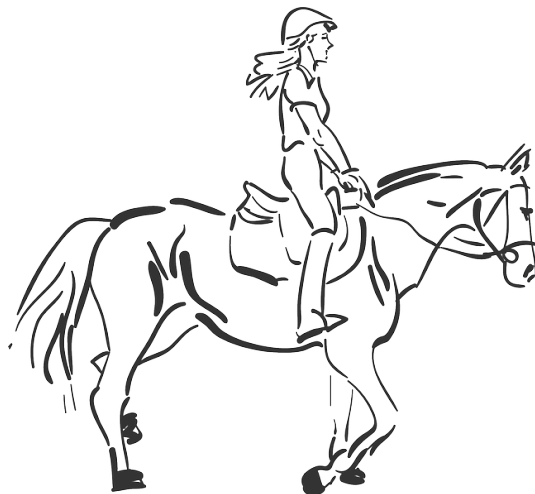

NAERIC RULES AND REGULATIONS

GENERAL RULES

- 1) The NAERIC Advantage® program reserves the right to modify the rules of this program to ensure that the original intent of the program does not become circumvented. Issues not addressed these rules, will be dealt with on a case-by-case basis. Questions should be put in writing and mailed or faxed a minimum of 21 days prior to the next scheduled NAERIC Advantage® Advisory Committee meeting. The Advisory Committee meets on a quarterly basis. The Advisory Committee makes recommendations to the NAERIC Board of Directors. The NAERIC Board of Directors, at their next regularly scheduled board meeting, will make final approval of program rules.
- 2) NAERIC reserves the right to alter the conditions of all or part of the NAERIC Advantage® as it, in its sole discretion, determines to ensure fairness and equality to all participants.
- 3) The NAERIC Board of Directors shall decide all disputes arising out of the application or interpretation of any rules or conditions of the NAERIC Advantage®.
- 4) An entrant is ineligible to participate in the NAERIC Advantage® when prohibited by law because of legal residence, situs of approved event, or any other basis, and all or the prohibited portion of earned points or purse money will not be eligible for matching payouts.
- 5) All correspondence may be based upon postmarked, e-mail or facsimile transmission date.
- 6) Fraudulent practices may serve as a basis to terminate NAERIC and local association memberships.
- 7) Documentation of fraudulent practices will be referred to Pfizer.
- 8) Fraudulent practices may serve as a basis to terminate NAERIC and Local Association memberships.
- 9) Suspension of the right to register horses with NAERIC will be instituted for violation of NAERIC Advantage® rules.
- 10) Ranchers forfeit the right to register horses with NAERIC on the date their contract is terminated or the last shipping date of the contract.
- 11) A listing of all horses registered with NAERIC will appear on NAERIC's web site, www.naeric.org.

HORSE APPROVAL

- 1) January 1 serves as the official birthday of horses.
- 2) Horses foaled prior to 1995 are ineligible.
- 3) Foals of 1995, 1996 and 1997, registered with a breed registry, whose breeder of record (owner of mare at time of service) could be verified as: 1) a member of NAERIC and their local association at the time of nomination, and; 2) a member of NAERIC and their local association in the year the foal was conceived and foaled, were eligible for the program under "grandfather" status. In order to qualify under grandfather status eligibility, registration with NAERIC had to be completed by December 31, 1998.
- 4) Non-registered foals of 1995, 1996 and 1997 were considered on a case-by-case basis under grandfather status until December 31, 1998.
- 5) "Grandfathered" horses registered with a breed registry and owned by a NAERIC member at the time of registration with NAERIC did not need to be electronically identified. "Grandfathered" horses owned by non-NAERIC members were required to be electronically identified.

6) A foal, registered with a breed registry, whose owner of the dam at time of service (breeder of record) can be verified as: 1) a current member of NAERIC and their local association, and; 2) a member of NAERIC and their local association in the year the foal was conceived and foaled, is eligible for the program until April 30 of the it's yearling year.

7) Member ranchers, applying for registration with NAERIC for non-registered foals, must be the owner of the foal's dam at the time of conception, foaling and application to NAERIC.

8) Horses not registered with a breed registry must be electronically identified.

9) Each horse must complete all requirements of the NAERIC registration process by deadline dates to be enrolled in the NAERIC Advantage®. Required elements are:

a) A completed Application for Registration for the current year.

b) A copy of the horse's registration papers if the horse is registered with a recognized breed registry.

c) The implantation of an approved microchip by the rancher (breeder) if the horse is not registered with a recognized breed registry.

d) Payment of fees due including any outstanding fees from previous years.

10) As of January 1, 1999, applications for foals of 1999 and later must be made to the Incentive Program prior to:

a) Eligibility for payout in any NAERIC-approved event

b) Transfer of ownership (Transfer of ownership occurs when the check clears the bank. NAERIC Applications for horses sold must be entered online at www.naeric.org no later than the 1st business day after the sale.)

c) Permanently leaving the ranch

In no case will a NAERIC Advantage® application be accepted after April 30 of an eligible horse's yearling year. After an application for a horse is submitted to NAERIC, the horse must be paid for. Neither credits nor refunds will be issued.

11) Offspring of leased mares will not be eligible for the NAERIC Advantage®.

EVENT APPROVAL

1) Events limiting participation to a certain group, where membership to that group is closed, will not be eligible for payouts.

2) Application materials for events to be considered for any year must be submitted electronically via the NAERIC web site 30 prior to the event. All approved events, for any given year, will be posted to www.naeric.org as soon as possible after approval.



RANCH APPROVAL

- 1) Beginning on June 1, 1998, and each successive June 1, only ranchers that are NAERIC and local association members, and have a contract with Pfizer Organics can register horses with NAERIC.
- 2) A contract holder's immediate family, including his/her spouse and children will be eligible to nominate horses if they "materially participate" (according to IRS regulations) in the management of the ranch.
- 3) In the case of partnerships, all parties must meet the eligibility requirements set forth under the Ranch Approval Process in order to nominate horses.

PAYOUTS

- 1) Starting year for NAERIC Advantage® approved events was 2006. NAERIC registered horses competing at approved events are eligible for payouts after payout applications are electronically submitted to NAERIC via the NAERIC web site, www.naeric.org and required documentation is received at the NAERIC office.
- 2) In order to qualify for payouts, approved horses and events must meet all eligibility requirements established by the governing body, which oversees the event. Payouts will be made in Canadian dollars (CD) if the original purse was in CD. Payouts will be made in United States dollars (USD) if the original purse was in USD.
- 3) Payouts made, to teams of horses, will be prorated based upon the number of approved horses comprising the team. For example, a six-horse hitch that earns a \$1,000 purse and is comprised of three approved horses, will receive a NAERIC Advantage® payout in the amount of \$500 (3/6 or 50% of the \$1,000 purse).
- 4) For a NAERIC horse used multiple times in one class at an event, NAERIC will match only the highest payout.
- 5) Payouts will be made according to the details listed for each event on the NAERIC site. No payouts will be made for qualifying rounds, showmanship, bareback riding, lead line and equitation or horsemanship type classes. The NAERIC Advantage® Advisory Committee and NAERIC Board of Directors will make final decisions regarding placing payouts, at individual events.
- 6) NAERIC Advantage® payouts will be made based upon, but not be limited to, official show results confirming horses' participation, placings and a copy of the purse check from the approved event.
- 7) The NAERIC horse must be identified in the show results with the horse's name as it appears on the breed registry papers and on the NAERIC certificate. A grade horse should be identified in show results with the name as it appears on the NAERIC certificate.
- 8) Payouts will be issued beginning February 1 of the year following the previous year's approved events.

Light Horse Show Entry Form
Phone (204) 734-8990
Email: srvaglighthorse@gmail.com
Swan River Valley Agricultural Society
Box 116, Swan River, MB R0L 1Z0

Entries CLOSE July 21, 2023 at 5:00PM.

ALL Gymkhana envelopes MUST be picked up by 6:00 Pm Friday July 28, 2023.

***ALL Exhibitors only entering gymkhana classes, must park on the North side of the infield. Signs will be posted. ABSOLUTLEY NO PARKING ON THE TRACK.**

Name: _____

Address: _____

Postal Code: _____

Email: _____

Phone number: _____

Total fees at \$3	
Total Fees at \$10	
Admin Fee (\$10/person)	
Adult Exhibitor Admission (\$35)	
Child Exhibitor (\$25)	
Helper pass (\$35)	
Non-Electrical Camping (\$30)	
Electrical Camping (\$50)	
Total Fees	

NAERIC Horses Names	Birth Date of Youth (Y/M/D)

Size of camping unit, including vehicle: _____ FT.

Total Number of stall needed: _____ (Limited box stalls available)

\$20/Stall on separate cheque: _____

E-Transfer: svagsociety@gmail.com

CASH or CHEQUE payable to *Swan River Valley Agricultural Society*

I hereby make the above entries, subject to the rules published in the prize list, which I agree to be bound by.

Signature of parent/guardian of youth under 18: _____

Signature of exhibitor (owner): _____

Entry Form

Horses Name: _____ Shown By: _____

Class	Entry Fee	Class	Entry Fee
1. Light horse 1 & 2 yr. old filly		49. Cross Rail Hunter (Max. 18")	
2. Light horse 1 & 2 yr. old gelding		50. Cross Rail Hunter (max. 24")	
3. Light horse 1 & 2 yr. old Stallion (reg.)		51. Show Hack	
4. Yield Mare 3 yrs. & over western type		52. Saddle Pony 14.2H & under	
5. Yield Mare or gelding 3 yrs. or over English\harness type		53. Senior English Pleasure	
6. Gelding 3 yrs. & over western type		54. PeeWee English Pleasure	
7. Stallion any light breed, registered 3 yrs. & over		55. Junior English Pleasure	
8. Get a Sire & Progeny of Dam.		56. PeeWee English Equitation	
9. Champion/Reserve Champion Mare or filly (1,4,5)		57. Junior English Equitation	
10. Champion/Reserve Champion Gelding (2,5,6)		58. Senior Western Pleasure	
11. Grand Champion/Reserve Champion Stallion (3,7)		59. PeeWee Western Pleasure	
12. Pony, filly, gelding, or stallion 1 & 2 yrs. old		60. Western Pleasure Horse 6 yrs. & over	
13. Pony Yield mare or gelding 3 yrs. & over		61. Local Saddle Horse/Pony Western	
14. Pony Stallion 3 yrs. & over		62. Family Riding Stake	
15. Champion Pony on Halter (12,13,14)		63. Western Pleasure Horse 5 yrs. & under	
16. Mini Showmanship		64. Pair of driving horses/ponies	
17. Junior Showmanship		65. Junior Western Pleasure	
18. PeeWee Showmanship		66. Pleasure driving pair, horses/ponies	
19. PeeWee Local Showmanship		67. Saddle Pairs-western equipment	
20. Senior Showmanship		68. Single Pleasure Driving Horse or Pony	
21. Novelty Costume		69. Open Junior/PeeWee Pleasure Driving	
22. Walk & Trot (10 yrs. old & under)		70. Combination Horse/Pony Harness/Saddles	
23. Hobby Stick Horse (Ring side entry)		71. Open Junior/Peewee Command Class	
24. Combination Horse or Pony – English to Western		72. Senior Command Class	
25. Junior Reining		73. Low Jumper	
26. PeeWee Reining.		74. Training Low Jumper (Max. 2'3")	
27. Senior Trail Stake		75. Open Jumper Stake (Max. 2'3")	
28. Junior Trail Stake		76. Joker Poker	
29. PeeWee Trail Stake		77. Road Hack	
30. Senior Barrel Race		78. Open Junior/PeeWee English Pleasure Stake	
31. Junior Barrel Race		79. PeeWee Local Equitation (Western/English)	
32. PeeWee Barrel Race		80. Senior English Pleasure Stake	
33. Open Barrel Stake		81. Senior English Equitation	
34. Senior Pole Bending		82. Saddle Pairs, English	
35. Junior Pole Bending		83. PeeWee Western Equitation	
36. PeeWee Pole Bending		84. Junior Western Equitation	
37. Open Pole Bending Stake		85. Senior Western Equitation	
38. Senior Keyhole Race		86. Junior Western Riding	
39. Junior Keyhole Race		87. Senior Western Riding	
40. PeeWee Keyhole Race		88. PeeWee Western Riding	
41. Senior Stake Race		89. Open Single Pleasure Driving (horse/pony)	
42. Junior Stake Race		90. Open Reinsmanship	
43. PeeWee Stake Race		91. Senior Western Pleasure Stake	
44. Open Junior/PeeWee Ribbon race		92. Open Junior/PeeWee Western Pleasure Stake	
45. Senior Ribbon Race		93. Senior Reining	
46. Lead Line (6 yrs. & under)		94. Open Reining Stake	
47. Beginning Hunter		95. Junior Ranch Riding	
48. Low Hunter Stake		96. PeeWee Ranch Riding	
Total		97. Senior Ranch Riding	
		Total	

Total number of classes: _____

Total Entry Fees: _____

Waiver of Claim

Date: _____

Time: _____

Name: _____

Address: _____

Home #: _____ Cell #: _____

In consideration of the undersigned being permitted to participate in any of the events carried on, sanctioned and/or sponsored by **North West Round-Up & Exhibition, Swan River Manitoba**, the undersigned shall save harmless and keep indemnified **North West Round-Up & Exhibition, Swan River, Manitoba**, their officers, agents, officials, servants, organizers and representatives from and against all claims, actions, costs, expenses and demands whatsoever concerning death, injury, loss or damage to the undersigned by virtue of his or her participation in said events howsoever caused and, regardless of whether same may have been contributed to or occasioned by the negligence of the said mentioned parties shall be deemed to be party to this agreement as if **North West Round-Up & Exhibition, Swan River, Manitoba** were acting as each party's trustee.

It is understood and agreed that this agreement is to be binding on myself, my heirs, executors and assigns and that I have read and fully comprehend this agreement.

Signature of Parent/Guardian youth under 18 years.

Signature of Participant